

MC 115 B

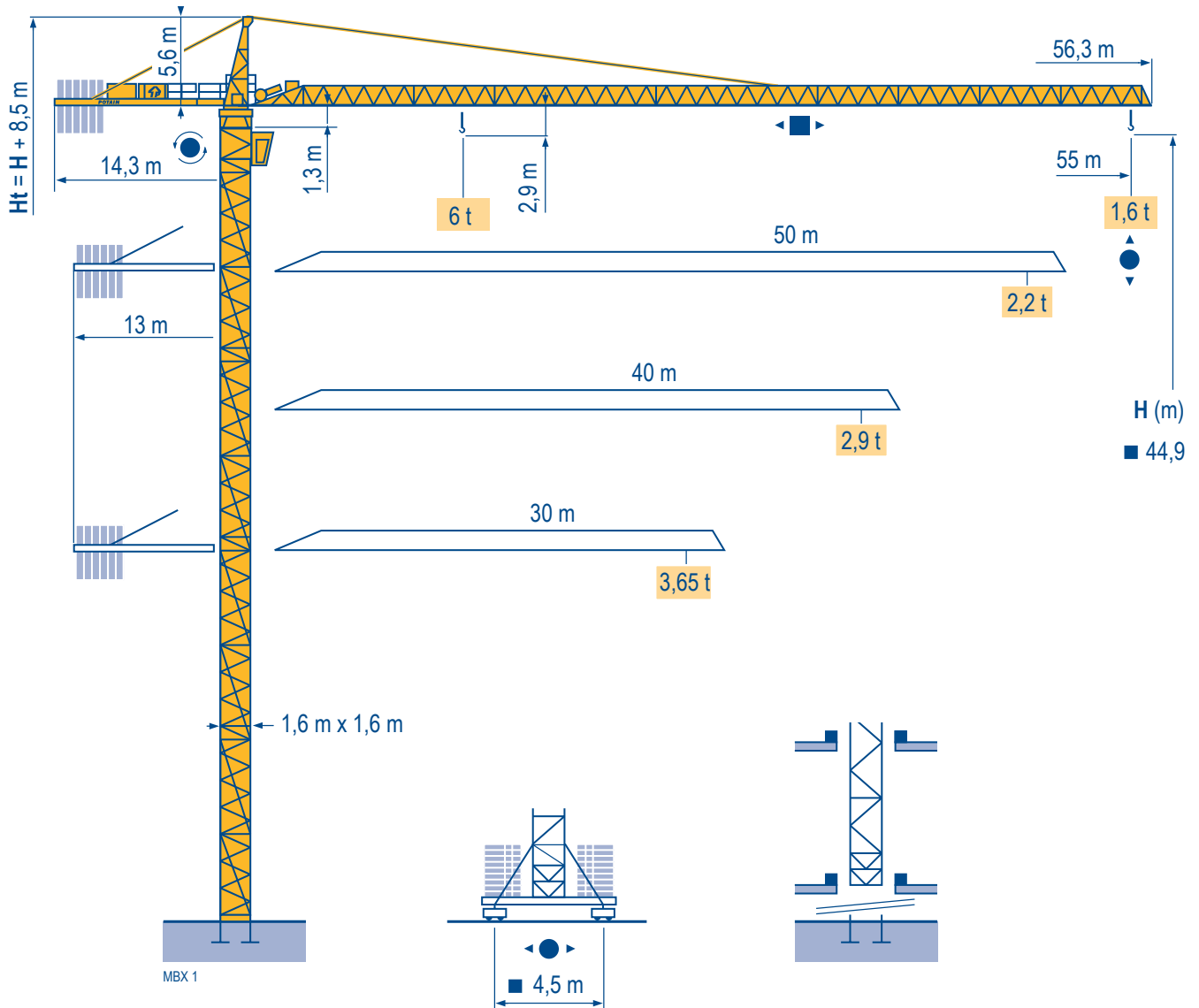

Masts / Reactions

□ 1,6 m
 ▴ 30 m → 55 m

MBX 2

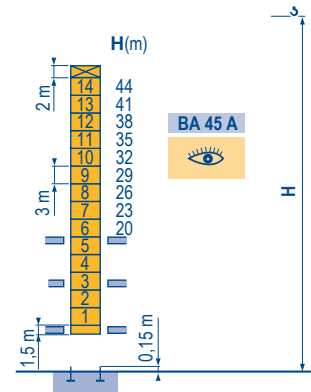
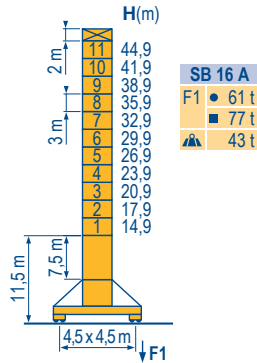
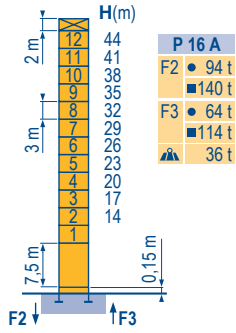

Climbing crane

MBX 1

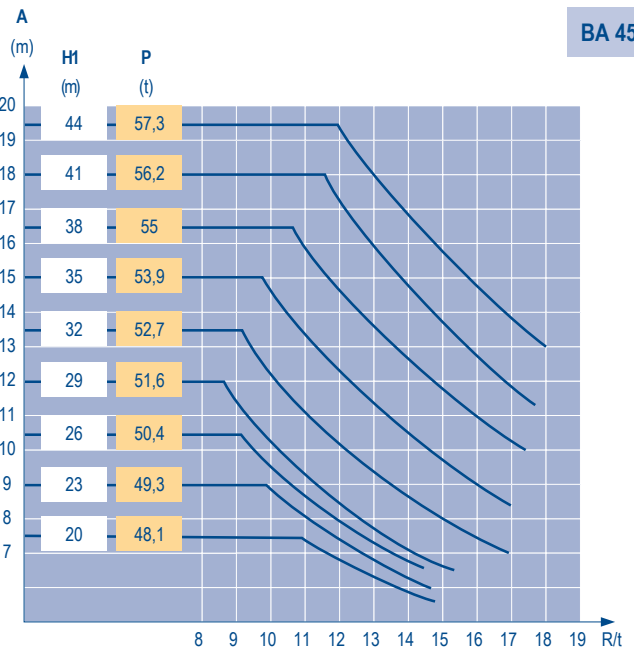
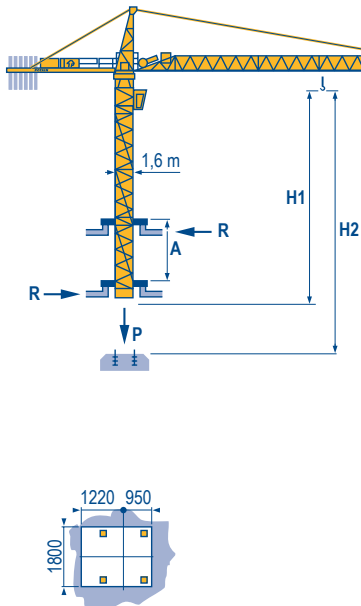

CITY CRANE
 MC 115 B



GB

- Reactions in service
- Reactions out of service
- ▲ Without load, ballast (or transport axles), with maximum jib and maximum height.
- 👁 See climbing crane

Load diagrams

MBX 1

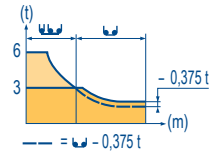
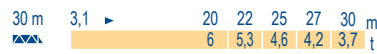
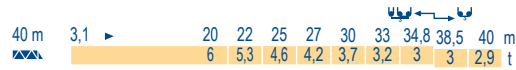
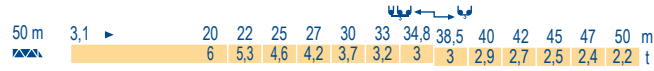
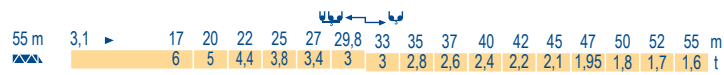

Counter-jib ballast

MBX 1

		3450 kg	2250 kg	(kg)
55 m	14,3 m	3	1	16 050
50 m	13 m	3	1	16 050
40 m	13 m	4	-	13 800
30 m	13 m	2	2	11 400

Base ballast

MBX 1

	SB 16 A - ●	H (m)	44,9	41,9	38,9	35,9	32,9	29,9	26,9	23,9	20,9	17,9	14,9
		(t)	66	54	42	42	42	42	42	42	42	42	42

Anchorage

MBX 1

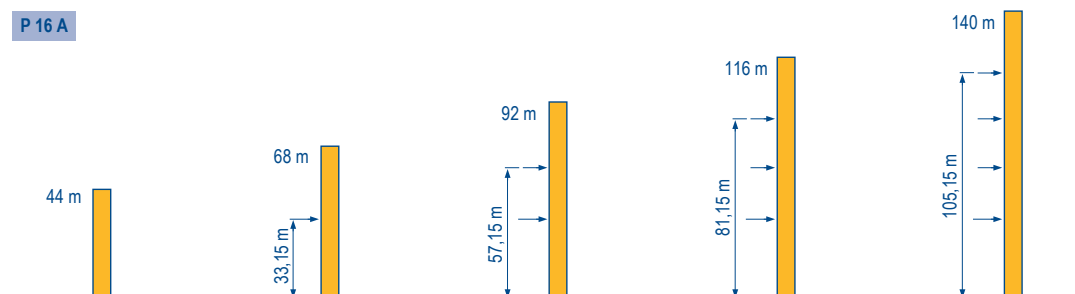

CITY CRANE MC 115 B















POTAIN

GB

- A** Distance between collars
- H1** Crane height
- P** Crane weight (in service)
- R** Horizontal reaction

Mechanisms

MBX 2

									hp	kW	
											
	33 PC 15	m/min	6,2	38	76	3,1	19	38	33	24	320 m
		t	3	3	1,5	6	6	3			
	4 D3 V3	m/min	15 - 30 - 58						4	3	
	RCV 145	rpm	0 → 0,8						2 x 6	2 x 4,4	
	SB 16 A RT 324 R ≥ 10 m	m/min	12,5 → 25						2 x 7	2 x 5,2	
CEI 38 			IEC 38			kVA					
400 V (+6% -10%) 50 Hz			33 PC : 50 kVA								

GB

-  Hoisting
-  Trolleying
-  Slewing
-  Travelling



This commercial document is not legally binding.
For any technical information, please refer to the corresponding instructions.

Manitowoc
Crane CARE

Manitowoc
Crane Group



Americas
Tel : +1 888 479 7278
Tel : +1 717 593 2000

Europe - Middle East - Africa
Tel : +33 (0) 4 72 81 50 00
Tel : +44 (0) 191 522 2000

Asia - Pacific
Tel : +65 6264 1188
Fax : +65 6862 4142

www.manitowoccrane.com

Manitowoc Crane Group Asia Pte Ltd
Manitowoc Crane Group
4 Kwong Min Road
Singapore 628707
Tel: +65 6264 1188
Fax: +65 6862 4040
www.manitowoccrane.com

MC 115 B
Réf. 2004 45 MBX 2

Copyright.Reproduction interdite © POTAIN 2004

Réalisation Secdoc