

永茂建机
YONGMAO

STT553
24/20/18t

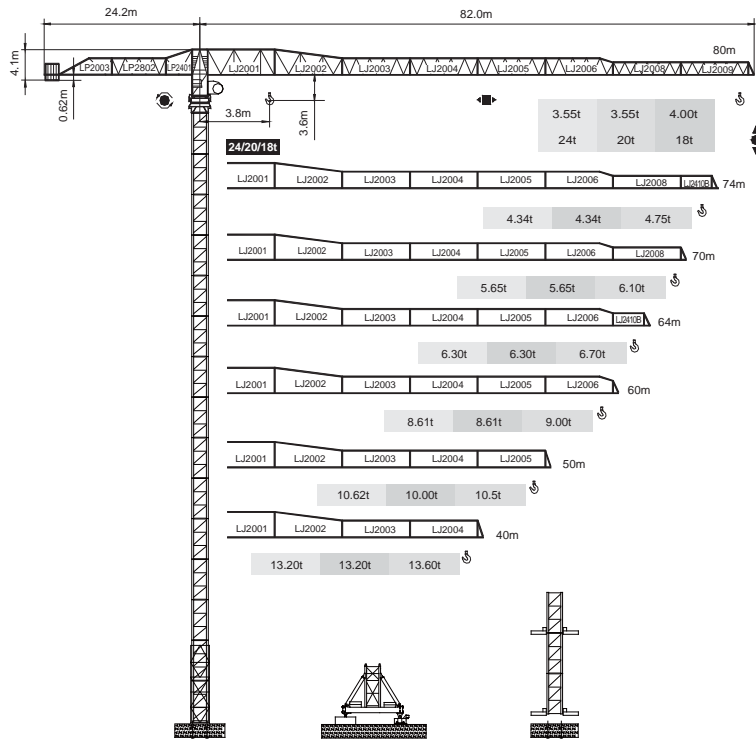

Topless

V 5.0-09112014

平頭系列

0 0
1 1
5 6

Topless STT553

Topless STT553

STT553
24/20/18t

载荷表 Load Chart

24t		Q-24-A(B)-1-V1.0											
R (m)	倍率 Fall	R(C _{max}) (m)	C _{max} (t)	30	40	44	50	54	60	64	70	74	80
80	UW	15.48	24.00	10.84	7.48	6.57	5.49	4.91	4.18	3.77	3.25	2.94	2.55
	LW	29.62	12.00	11.83	8.47	7.57	6.49	5.90	5.18	4.77	4.24	3.94	3.55
74	UW	16.60	24.00	11.76	8.16	7.19	6.04	5.42	4.65	4.21	3.66	3.34	
	LW	31.81	12.00	12.00	9.20	8.23	7.07	6.44	5.66	5.22	4.66	4.34	
70	UW	19.16	24.00	14.17	9.96	8.82	7.46	6.73	5.81	5.30	4.65	4.34	
	LW	36.91	12.00	12.00	10.95	9.81	8.46	7.73	6.81	6.30	5.65		
64	UW	19.16	24.00	14.17	9.95	8.82	7.46	6.73	5.81	5.30			
	LW	36.91	12.00	12.00	10.95	9.81	8.46	7.72	6.81	6.30			
60	UW	23.19	24.00	17.83	12.67	11.28	9.62	8.73	7.61				
	LW	44.91	12.00	12.00	12.00	12.00	10.62	9.73	8.61				
50	UW	23.19	24.00	17.82	12.67	11.28	9.62						
	LW	44.91	12.00	12.00	12.00	12.00	10.62						
40	UW	23.97	24.00	18.53	13.20								
	LW	40.00	12.00	12.00	12.00								

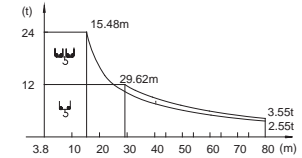

20t		Q-20-A(B)-1-V1.0											
R (m)	倍率 Fall	R(C _{max}) (m)	C _{max} (t)	30	40	44	50	54	60	64	70	74	80
80	UW	18.08	20.00	10.84	7.48	6.57	5.49	4.91	4.18	3.77	3.25	2.94	2.55
	LW	34.67	10.00	10.00	8.47	7.57	6.49	5.90	5.18	4.77	4.24	3.94	3.55
74	UW	19.39	20.00	11.79	8.18	7.21	6.05	5.43	4.65	4.22	3.66	3.34	
	LW	37.28	10.00	10.00	9.21	8.23	7.07	6.44	5.66	5.22	4.66	4.34	
70	UW	22.42	20.00	14.17	9.96	8.82	7.46	6.73	5.81	5.30	4.65	4.34	
	LW	43.30	10.00	10.00	10.00	9.82	8.46	7.73	6.81	6.30	5.65		
64	UW	22.42	20.00	14.17	9.96	8.82	7.46	6.73	5.81	5.30			
	LW	43.30	10.00	10.00	10.00	9.82	8.46	7.73	6.81	6.30			
60	UW	27.17	20.00	17.83	12.67	11.28	9.62	8.73	7.61				
	LW	52.70	10.00	10.00	10.00	10.00	10.00	9.72	8.61				
50	UW	27.46	20.00	18.02	12.74	11.32	9.62						
	LW	50.00	10.00	10.00	10.00	10.00	10.00						
40	UW	28.65	20.00	18.91	13.20								
	LW	40.00	10.00	10.00	10.00								

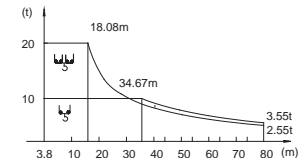

Topless STT553



YONGMAO HOLDINGS LIMITED



YONGMAO HOLDINGS LIMITED

平頭系列

STT553
24/20/18t

18t Q-18-A(B)-1-V1.0

R (m)	倍率 Fall	R(C _{max}) (m)	C _{max} (t)	30	40	44	50	54	60	64	70	74	80
80	UU	20.60	18.00	11.74	8.40	7.50	6.42	5.84	5.12	4.71	4.19	3.89	3.50
	UJ	38.70	9.00	9.00	8.68	7.82	6.79	6.24	5.55	5.16	4.66	4.37	4.00
74	UU	21.39	18.00	12.59	9.02	8.07	6.93	6.31	5.54	5.12	4.57	4.25	
	UJ	41.56	9.00	9.00	8.45	7.35	6.75	6.01	5.59	5.06	4.75		
70	UU	25.60	18.00	15.07	10.88	9.75	8.40	7.67	6.76	6.25	5.60		
	UJ	49.10	9.00	9.00	9.00	9.00	8.82	8.11	7.23	6.74	6.10		
64	UU	25.30	18.00	14.88	10.76	9.64	8.31	7.60	6.70	6.20			
	UJ	48.90	9.00	9.00	9.00	9.00	8.78	8.08	7.19	6.70			
60	UU	30.70	18.00	18.00	13.35	11.98	10.33	9.44	8.33				
	UJ	60.00	9.00	9.00	9.00	9.00	9.00	9.00	9.00				
50	UU	30.60	18.00	18.00	13.43	12.10	10.50						
	UJ	50.00	9.00	9.00	9.00	9.00	9.00						
40	UU	30.60	18.00	18.00	13.60								
	UJ	40.00	9.00	9.00	9.00								

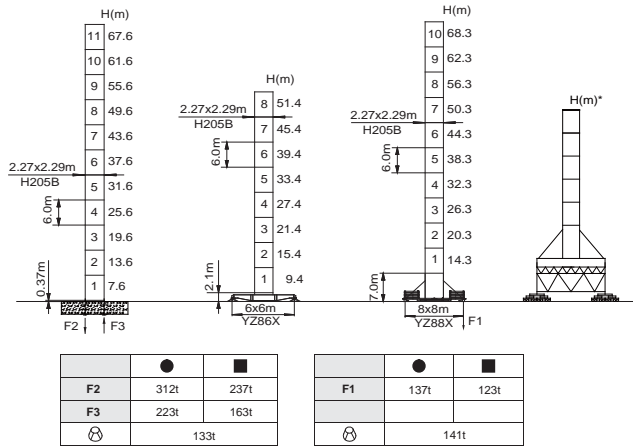
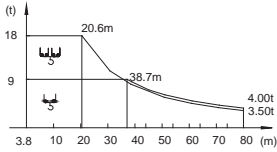

Topless STT553

STT553
24/20/18t

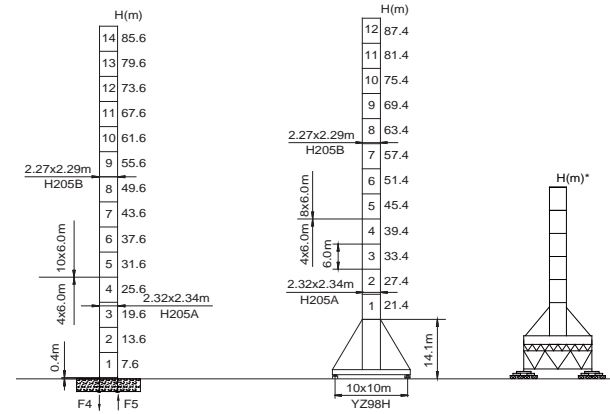

● 工作狀態支反力 In service reaction ■ 非工作狀態支反力 Out of service reaction
⊗ 整機自由高度重量(不含平衡重及懸吊重量) Total weight of free standing crane (excludes counter weight & ballast)

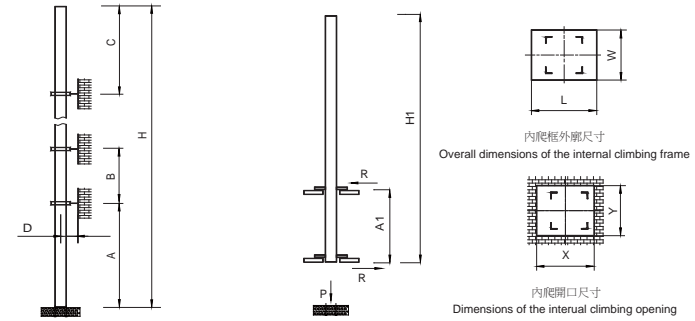

塔身節 Mast	A (m)	B (m)	C (m)	D (m)	H (m)
H205B	57	42	52.6	>4.0	400 >400*

塔身節 Mast	H1 (m)	A1 (m)	P (t)	R (t)	X (m)	Y (m)	L (m)	W (m)
H205B	61.2	20	159	42	3.28	2.4	3.5	3.02

附著道數 Number of tie collars =(H-A-C)/B+1

超過100m高度，需降低載荷，請與公司聯繫。

Load should be reduced when the height exceeds 100m. Please contact Yongmao for details.

0 0
1 1
7 8

Topless STT553
Topless STT553



YONGMAO HOLDINGS LIMITED



YONGMAO HOLDINGS LIMITED

STT553





24/20/18t

STT553

24/20/18t

平頭系列

主要性能參數 Specification

機構 Mechanism		U		UU		 電動機 Motor kW	
		m/min	t	m/min	t		
24t	90LFV60★	0-38 0-46 0-72	12.0 10.0 4.0	0-19 0-23 0-36	24.0 20.0 8.0	550 m	90
	90LFV60DB1	0-40 0-96 0-160	12.0 4.0 1.0	0-20 0-48 0-80	24.0 8.0 2.0	1030m >1030m*	90
20t	90LFV50★	0-37 0-44 0-75	10.0 8.0 3.0	0-18 0-22 0-37	20.0 16.0 6.0	550m	90
	75LFV50DB1	0-32 0-96 0-150	10.0 3.0 1.0	0-16 0-48 0-75	20.0 6.0 2.0	1030m >1030m*	75
18t	75LFV45★	0-38 0-46 0-76	9.0 6.0 3.0	0-19 0-23 0-38	18.0 12.0 6.0	680 m	75
	75LFV45DB1	0-40 0-96 0-160	9.0 3.0 1.0	0-20 0-48 0-80	18.0 6.0 2.0	1030m >1030m*	75
	11 DFV10	0-65 m/min					11
	7.5RFCV	0-0.8 rpm					3x145 N.m
	RTC435★	0-0.8 rpm					3x145 N.m
	RT	12.5-25 m/min					6x2.6/5.2

供電容量 Power supply	kVA
380V (±10%) 50 Hz	90LFV60, 90LFV60DB1, 90LFV50 : 135 75LFV50DB1, 75LFV45, 75LFV45DB1 : 115

* 與製造商聯繫 Contact us, please.
★ 标准配置 Standard configuration.

本技術參數不受法律約束，技術資訊請詳見相應說明書。
These specifications and data are not legally binding. For any technical information, please refer to corresponding instructions.



YONGMAO HOLDINGS LIMITED



YONGMAO HOLDINGS LIMITED

Topless STT553
Topless STT553